

## Peripheral Equipment / Specifications

### ■LITHIUM-ION BATTERY BP-900 (CE) / BP-900 (UL)

The BP-900 is a rechargeable lithium-ion battery designed for exclusive use with the conference units TS-801, TS-802, TS-901, and TS-902.



|                       |   |
|-----------------------|---|
| Nominal Voltage       | 7.4 V DC  |
| Nominal Capacity      | 1700 mAh  |
| Operating Temperature | 0°C to +40°C  |
| Dimensions            | 71.6 (W) × 20.4 (H) × 37.6 (D) mm                             |
| Weight                | 95 g  |
| Accessory             | Terminal protection cover (pre-installed at the factory) ···1 |

### ■BATTERY CHARGER BC-900

The BC-900 is a dedicated battery charger for the BP-900 (optional) used in the Chairman Units, and Delegate Units. It permits up to 8 batteries to be simultaneously charged within up to 5 hours.



|                       |  |
|-----------------------|--|
| Power Source          | 100-240V AC, 50/60 Hz (supplied from AC adapter (accessory))             |
| Current Consumption   | Max. 5A  |
| Charging Time         | Approx. 5 hours  |
| Charging Capacity     | 8 BP-900 batteries (option)  |
| LED Indicator         | Charging status (Green: Full charge, Red: On charge), Power indicator    |
| Operating Temperature | 0°C to +40°C   |
| Finish                | Case: Steel, black, paint<br>Battery receptacles: PPO resin, black       |
| Dimensions            | 240 (W) × 70 (H) × 115 (D) mm  |
| Weight                | Unit: 1.1 kg, AC adapter: 520 g  |
| Accessory             | AC adapter (Cord length: 1.5 m DC cord, and 2 m detachable AC cord) ···1 |

### ■RACK MOUNTING BRACKET MB-TS900

The MB-TS900 Rack Mounting Bracket is designed for exclusive use with the Central units TS-800 and TS-900 of the TOA Infrared Conference Systems.

The MB-TS900 is a 4-units size that can be mounted in an EIA Standard equipment rack.

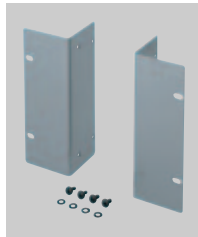

|            |   |
|------------|---|
| Finish     | Surface-treated steel plate, gray metallic, paint, semi-gloss |
| Dimensions | 65.5 (W) × 177 (H) × 61 (D) mm                                |
| Weight     | 680g  |
| Accessory  | Rack mounting screw ···4, Rack mounting washer ···4           |

### ■AC ADAPTER AD-0910

The AD-0910 is an AC adapter to operate the Chairman units TS-801 and TS-901, and the Delegate units TS-802 and TS-902 on AC.



|                       |                           |
|-----------------------|---------------------------|
| Power Source          | 100-240V AC, 50/60Hz      |
| Output                | 9V DC, 1 A                |
| Ripple Voltage        | 100mV (p-p)               |
| Power Consumption     | 400mA AC, Input 100V      |
| Cord Length           | 1.8m                      |
| Plug                  | RC6705, center " + "      |
| Operating Temperature | 0°C to +40°C              |
| Finish                | Case: PC/ABS alloy, black |
| Weight                | 190g                      |
| Accessory             | AC power cord (2 m) ···1  |

### ■DISTRIBUTOR YW-1022 (to 2 outputs), YW-1024 (to 4 outputs)

The YW-1022, YW-1024 is a distributor that can work in the frequency range of 1.6 to 1,000 MHz (except 50 to 70 MHz). Power passing type permits easy power supply.



|                        | YW-1022   | YW-1024   |
|------------------------|---|---|
| Frequency Range        | 1.6-1,000 MHz (excluding 50 - 70 MHz)   |   |
| Distribution Loss      | 4.5dB ±3dB (between the Mixing and each Distribution terminals)   | 8.5dB ±3dB (between the Mixing and each Distribution terminals) |
| Input/Output Impedance | 75 Ω  |   |
| Coaxial Connector      | Mixing terminal: BNC jack, power passing type (under 30 V DC, under 2 A)<br>Distribution 1 and 2(YW-1022) / 1-4(YW-1024) terminals: BNC jack, power passing type (under 30 V DC, under 1 A) |   |
| Operating Temperature  | -10°C to +50°C  |   |
| Finish                 | ABS resin, gray   |   |
| Dimensions             | 75 (W) × 122 (H) × 34 (D) mm  |   |
| Weight                 | 105g  | 120g  |



# Infrared Conference System

## TS-900/800 Series

Installation made easier than ever thanks to infrared system coupled with clear sound amplification.

Cordless conference system provides flexible adaptation to diverse styles of conference.



TOA Corporation  
www.toa.jp

Specifications are subject to change without notice.  
Printed in Japan (0407) 833-52-319-60 u

# Infrared communication system contributes to smoother management of medium to small-scale conferences

## Higher security with infrared communication

The system's infrared communication method is not only resistant to radio interference and eavesdropping, but it also permits simultaneous use of systems in adjacent conference rooms with no crosstalk.

## Easy installation

Infrared communication system eliminates the need of connecting the conference units. Installation can be done quick and smart without cumbersome cable arrangements.

## Easy connection with a single coaxial cable

Central unit and Infrared Transmitter/Receiver unit can be connected using a single coaxial cable.

## Flexible adaptation to change of the number of participants or layout

Up to 96 Chairman and Delegate units can be used per system for TS-900 Series (up to 64 Chairman and Delegate units for TS-800 Series). Cordless and easy-to-relocate feature makes the system ideal for any conference apt to change the number of participants or layout.

## Compact light-weight Chairman/Delegate units

Microphone, monitor speaker, Talk key and Speech indicator are totally integrated. When the unit's Talk key is pressed, the Microphone indicator lights up to enter the mode accepting a speech. Microphone is removable for compact storage.

## Clear sound amplification and recording

The Chairman/Delegate units have a built-in monitor speaker which makes talker's voice clearly audible at seat. When recording equipment is connected to the Central unit, clear recording is possible which is indispensable in preparing conference minutes.

## Selectable power supply system

Both Chairman and Delegate units can be operated on either their built-in rechargeable lithium-ion batteries (for approx. 10 hours use) or AC power supply. Battery charger can recharge up to 8 lithium-ion batteries at a time in about 5 hours.

## Adjustable to broader area use

Up to 16 Infrared Transmitter/Receiver units can be connected to expand the area of infrared communication coverage using a distributor.

## Capability of manipulation from PC or console (customized)

Using the dedicated software, it is possible to control the system from PC or console to perform recording, giving permission of speech, and other operations.

## Other features

The Chairman unit features a priority speech key which allows it to take precedence over Delegate units when speaking.

Sounds from a wired microphone or sound source equipment can be heard from the Chairman/Delegate units' speakers.

Two types of dedicated microphones are made available for the Chairman and Delegate units: "standard" (368 mm long) and "long" (518 mm long).

Besides ceiling or wall mounting, the Infrared Transmitter/Receiver unit can also be tentatively installed on a microphone stand (applicable thread size: W 5/16).



## Remarkable Functionality

### Six features addressing various conference management needs

#### Features common in TS-900/800 series

#### 1 Speaker restriction function to prevent speech interruption

The number of conference units can be set for any of one, two or four persons allowed to talk at a time, preventing possible disorder that could result from simultaneous speeches by participants.



#### 2 Speech system selection function to set priority of speech

When the Talk keys on the conference units are pressed beyond the restricted number of talkers, the microphone ON/OFF operation can be set to any of the following; first-in-first-out, last-in-first-out, or last-in-first-out after 2nd unit (the microphone stays ON for the unit whose Talk key was first pressed).



#### 3 Auto Mic-Off function to prevent inadvertent microphone shutoff failure

When this function is set to ON, the microphone automatically turns off if duration of silence lasts for 30 seconds after it is ON by pressing the Talk key.



#### 4 Installation status checkup function to show communicable units at a glance

When operated on the Central unit, the microphone indicators on the Chairman/Delegate units light up. In TS-900 series, the Central unit can indicate the number of units. This feature allows the prior system check to see if all units are capable of infrared communication.

#### Features in TS-900 series only

#### 5 Threefold choice vote function for instantaneous voting and totalization (TS-900 series only)

TS-900 series Chairman/Delegate units feature the Vote key for threefold choice to enable easy balloting by participants. The result is indicated on the Central unit, allowing a quick vote.

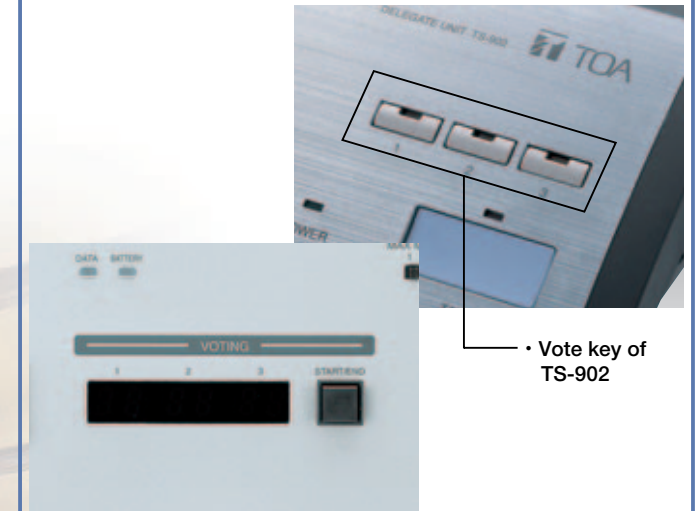

• Vote result indicator of TS-900

#### 6 Main/Sub audio function to allow bilingual conference (TS-900 series only)

TS-900 series system is capable of providing two types of audios (main and sub) besides the conference unit's speech voice.

In TS-900 series, the Chairman/Delegate units are equipped with the monitor selector key which enables monitoring of desired main or sub audio.



• Monitor selector key of TS-902

## TS-900 Series System Example (Bilingual Conference System)

### TS-900 Series

High-end system with versatile functions to support sophisticated conference styles

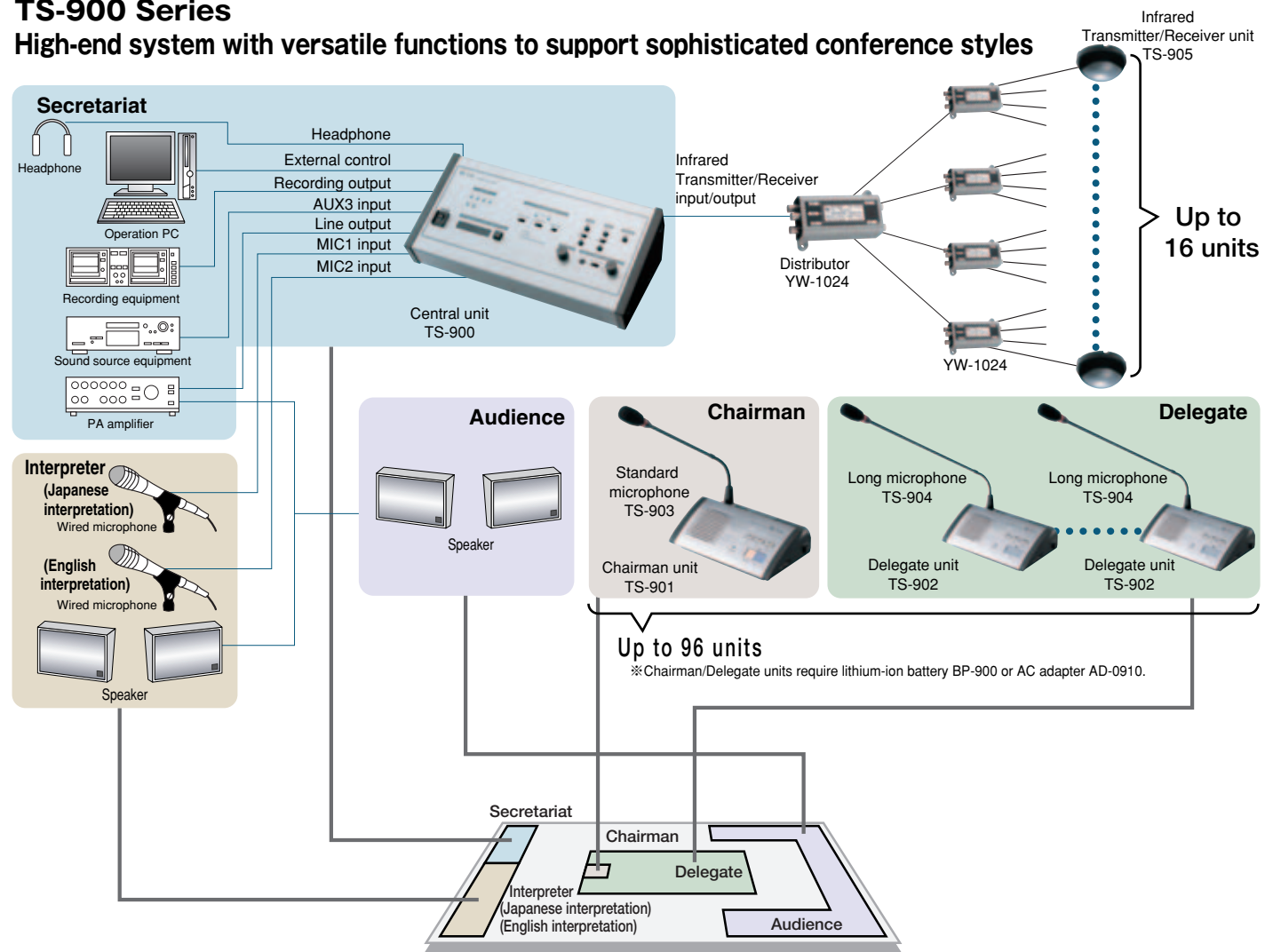

### System Features and Outline

- Japanese/English bilingual conference system. Either Japanese interpretation (main audio) or English interpretation (sub audio) is selectable for monitoring.
- Operations such as giving speech permission can be done from the operation PC. ※Custom design. Operation is possible without PC.
- The number of conference units can be set for any of one, two or four persons allowed to talk at a time.
- All speeches during the conference can be recorded clearly. ※English interpretation is not recorded.
- Threefold choice vote function enables the voting just at the press of a key on each unit. The result can be instantly totalized on the Central unit.
- Speeches can be addressed to audience via sound amplification.
- Interaction capability with camera system (customized). A talker can be pictured automatically if so preset.

### Parts Designation

#### TS-900 Series

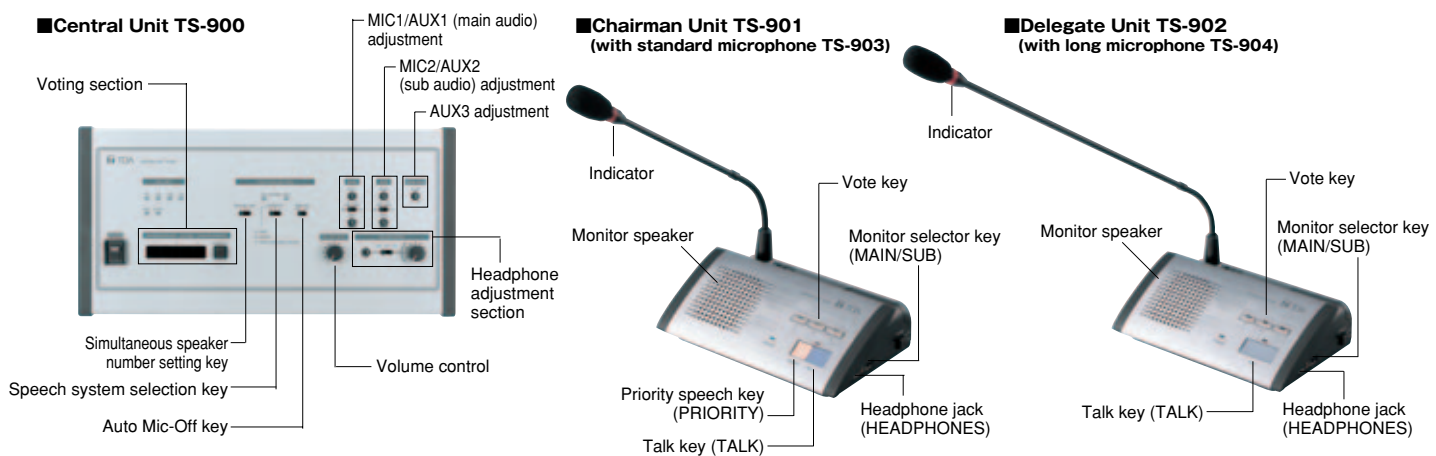

## TS-800 Series System Example (Standard Conference System)

### TS-800 Series

Simple style conference system with ultimate ease of use

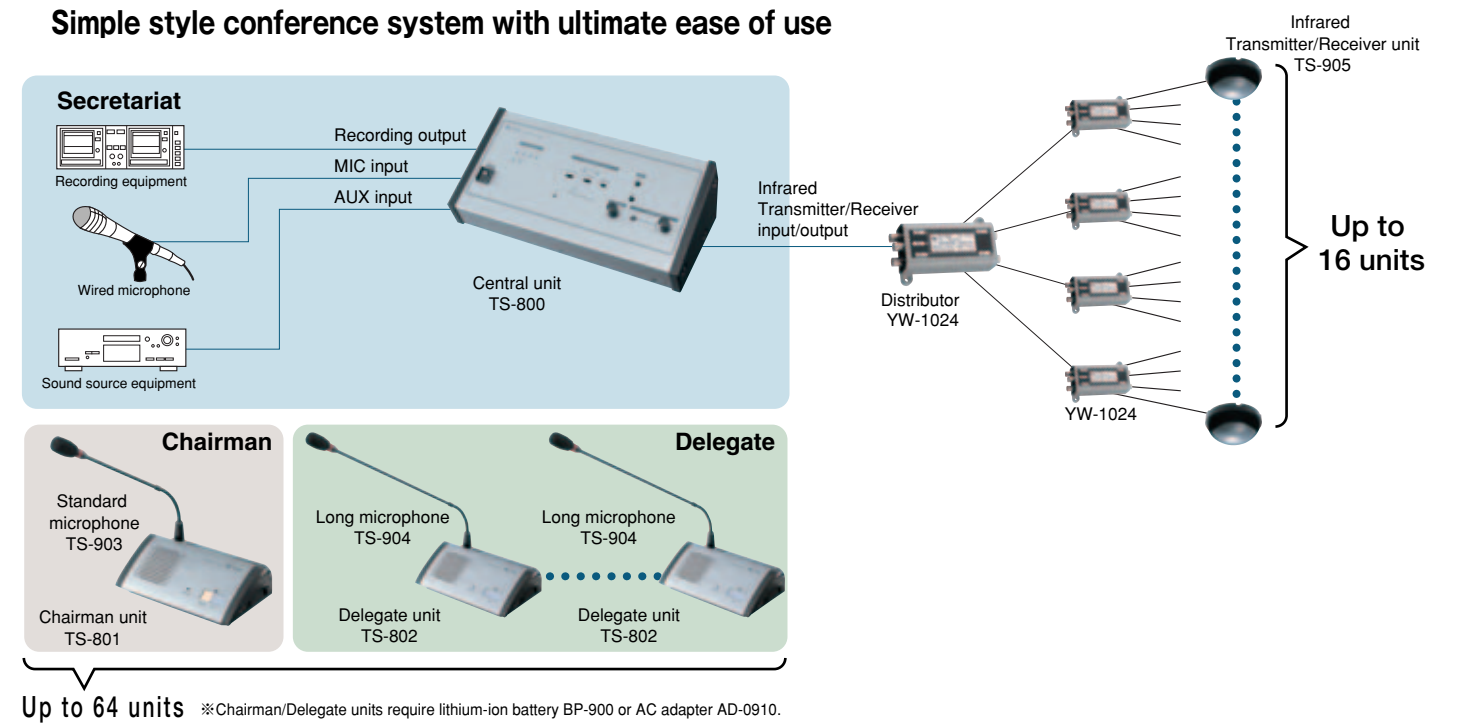

### System Features and Outline

- Conference system for usual meetings
- The number of conference units can be set for any of one, two or four persons allowed to talk at a time.
- All speeches during the conference can be recorded clearly.
- As a custom feature, the operation of giving speech permission can be controlled from PC. Interaction with camera system is also available as a custom design.

### Parts Designation

#### TS-800 Series

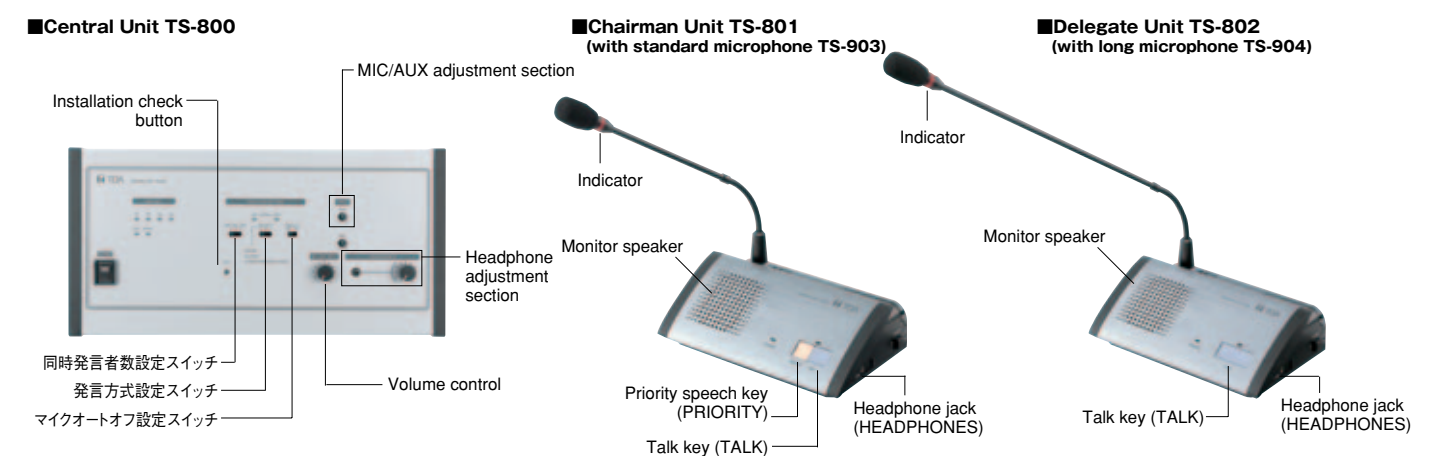

## Notes on Installation of Infrared Transmitter/Receiver Unit

- Make sure to position the Chairman/Delegate units within 7 meters from the Infrared Transmitter/Receiver unit.
- Infrared light will not reach the Infrared Transmitter/Receiver unit if it is located behind user or other obstacles. Install the Infrared Transmitter/Receiver units in such a way that two or more units are visible from the Chairman/Delegate units.
- With only one Infrared Transmitter/Receiver unit used for communication, the reception can be interrupted if infrared signal is obstructed by a person or an obstacle. Install two or more Infrared Transmitter/Receiver units so that the Chairman/Delegate units can communicate with them at all times.
- Install the Infrared Transmitter/Receiver units at least 2-3 meters away from the nearest window. Cover the windows with curtains or blinds to keep the units free from direct sunlight.
- Position the units at least 50 cm away from fluorescent lights.
- Keep away other infrared light sources.  
Lighting equipment, LCD projectors, overhead projectors, incandescent lamps, mercury-arc lamps, plasma displays, remote controllers, infrared microphones, infrared equipment such as infrared LANs, dimmers

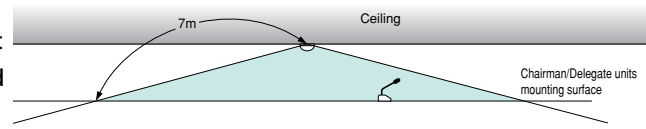

## Infrared Transmitter/Receiver Units Arrangement Examples

### [Conference room with 30 x 30 m area]

When the ceiling is lower than 3 meters, preferably arrange the units 6-8 meters apart from each other as shown in the figure. A service area covering every corner of the room can be secured.

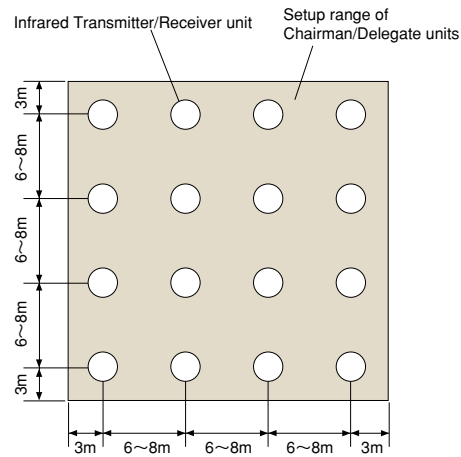

### [Conference room using a round table]

All Chairman and Delegate units are arranged around the table, in which case only one Infrared Transmitter/Receiver unit may suffice for complete coverage of conference communications.

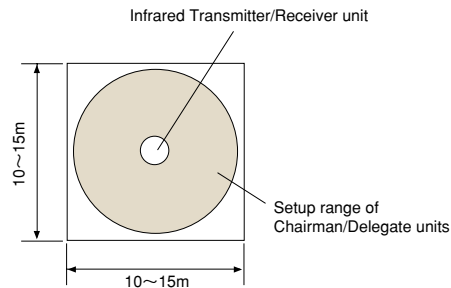

## Notes on wiring

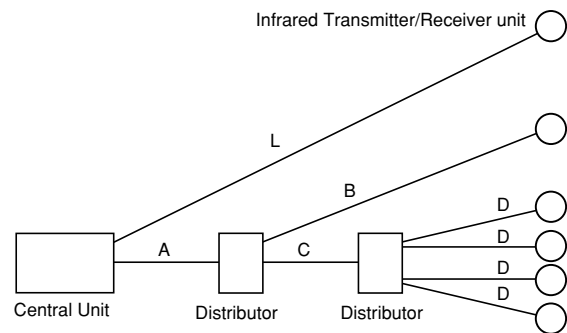

If two or more Infrared Transmitter/Receiver units with different connection cable lengths receive infrared signals from the Chairman and Delegate units, the signal reception level may decrease to cause malfunction.

- Ensure that the cable length between Infrared Transmitter/Receiver unit and Central unit is identical.  
**Length between each Infrared Transmitter/Receiver unit and the Central unit: L=A+B=A+C+D**

※ This length must always be the same even if a distributor is included in the wiring.  
Length between Infrared Transmitter/Receiver unit and distributor: D  
Length between distributors (where two distributors are connected): C  
Length between distributor and Central unit: A  
(In the above figure, no matching is needed because there is only one A line.)

## Distributor use

- Avoid connecting more than 2 distributors in series. Connecting 3 or more distributors increases high frequency signal loss, and could result in system malfunction.
- It is possible to mix Infrared Transmitter/Receiver units not connected to any distributor, those connected to 1 distributor, and those connected to 2 distributors in the same system.

## Conditions for finding maximum cable length

The maximum cable length between each Infrared Transmitter/Receiver unit and the Central unit differs depending on the type of coaxial cable used. The following two requirements must be met. The shorter length of the two results is considered to be the maximum length allowed. Do not exceed the maximum cable length.

### 1. Maximum allowable cable loss: 20 dB \_ Total distributor loss (varying with type of distributor and the number of serially-connected distributors)

### 2. Maximum allowable cable DC voltage drop: 5 V

※ For more details, please contact your dealer.

## Dimensions / Specifications

### TS-900 / TS-800 (Central Unit)

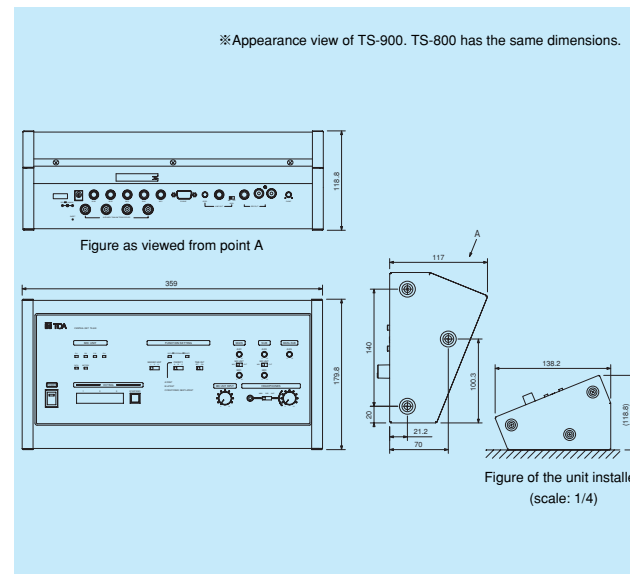

### TS-901 / TS-801 (Chairman unit) / TS-902 / TS-802 (Delegate unit)

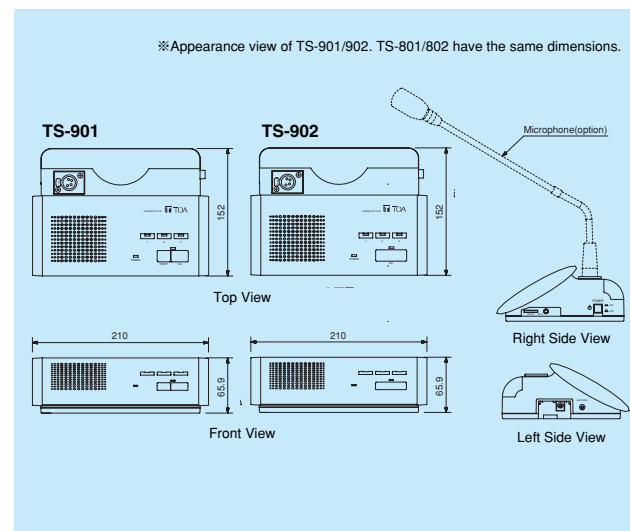

### TS-905 (Infrared Transmitter/Receiver unit)

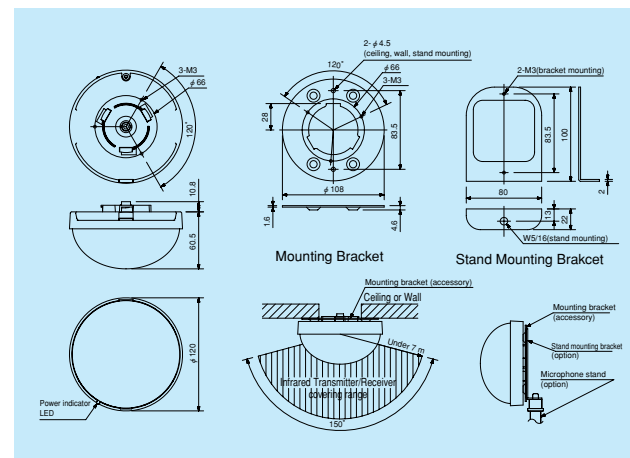

### TS-903 (Standard microphone), TS-904 (Long microphone)

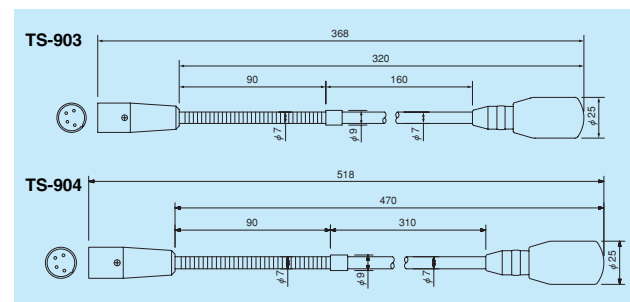

| Model No.   | TS-900   | TS-800  |
|---|--|---|
| Power Source  | 100-240 V AC, 50/60Hz (supplied from AC adapter (accessory))   |   |
| Power Consumption   | 72W  |   |
| Input   | MIC1 (Base Language): -60 dB * 600 Ω unbalanced, phone jack<br>MIC2 (Translation Language): -60 dB * 600 Ω unbalanced, phone jack<br>AUX1 (Base Language): -20 dB * 10 k Ω unbalanced, phone jack<br>AUX2 (Translation Language): -20 dB * 10 k Ω unbalanced, phone jack<br>AUX3 (Base and Translation Language): -20 dB * 10 k Ω unbalanced, phone jack | MIC: -60 dB *, 600 Ω unbalanced, phone jack<br>AUX: -20 dB *, 10 k Ω unbalanced, phone jack   |
| Output  | LINE: -20 dB *, 10 k Ω unbalanced, phone jack<br>REC: -20 dB * 10 k Ω unbalanced, phone jack, RCA pin jack<br>HEADPHONE: Mini jack   | REC: -20 dB *, 10 k Ω unbalanced, phone jack, RCA pin jack<br>HEADPHONE: Mini jack  |
| Number of Connectable Chairman/Delegate Units             | 96 units   |   |
| Number of Connectable Infrared Transmitter/Receiver Units | 4 units (up to 16 units by using four Distributors)  |   |
| Infrared Transmitter/Receiver I/O Terminal                | 4 BNC jacks  |   |
| External Control Terminal                                 | D-sub connector (9 P, male)  |   |
| LED Indicator   | Voting result indicators 1-3 (7-segment LED, double-digit number)<br>Audio signal receiving indicators 1-4 CH. Data signal receiving indicator.<br>External control priority indicator. External control communication indicator.<br>Power indicator. Battery indicator (flashes when a Chairman/Delegate unit's battery nears complete discharge)       | Audio signal receiving indicators 1-4 CH. Data signal receiving indicator. External control priority indicator. External control communication indicator. Power indicator. Battery indicator (flashes when a Chairman/Delegate unit's battery nears complete discharge) |
| Function Switch   | Simultaneous speaker No. setting switch: 1/2/4 Mic-off setting switch: TIME OUT ON/OFF<br>Speech priority selector switch: A/B/C<br>(A: First-in-first-out priority, B: Last-in-first-out priority, C: Fixed for the first unit, and last-in-first-out for the subsequent units)   |   |
| Microphone Mix/Cut Switch (for the Base Language)         | MIC/CUT (Mix): Chairman/Delegate units + MIC 1 + AUX 1 + AUX 3<br>→ Base Language (Cut): MIC 1 + AUX 1 + AUX 3 → Base Language   | —   |
| Microphone Mix/Cut Switch (for the Translation Language)  | MIC/CUT (Mix): Chairman/Delegate units + MIC 2 + AUX 2 + AUX 3<br>→ Translation Language (Cut): MIC 2 + AUX 2 + AUX 3 → Translation Language   | —   |
| AUX 3 Mixing Select Switch                                | MIC/CUT (Mix): AUX 3 input is relayed to the line output.<br>(Cut): AUX 3 input is not relayed to the line output.   | —   |
| Operating Temperature                                     | 0°C to +40°C   |   |
| Finish  | Panel: Surface-treated steel plate, gray metallic, paint, semi-gloss   |   |
| Weight  | 2.8kg  |   |
| Accessory   | AC adapter (Cord length: 1.8 m DC cord, and 2 m detachable AC cord) ... 1  |   |
| Option  | Rack mounting bracket: MB-TS900 * 0dB=1V   |   |

| Model No.                    | TS-901 · TS-902  | TS-801 · TS-802                    |
|------------------------------|--|------------------------------------|
| Power Source                 | 7.4 V DC (battery), 9 V DC (AC adapter)<br>(supplied from BP-900 battery (option) or AD-0910 AC adapter (option))  |                                    |
| Current Consumption          | MAX. 270 mA  |                                    |
| Wavelength                   | 870 nm (AM: Brightness modulation)   |                                    |
| Modulation Method            | Frequency modulation   |                                    |
| Carrier Frequency            | Transmission: Audio channel 1: 7.35 MHz<br>Audio channel 2: 8.10 MHz<br>Audio channel 3: 8.55 MHz<br>Audio channel 4: 9.15 MHz<br>Control channel: 6.45 MHz  | Reception: Audio channel: 1.95 MHz |
| Infrared Emitter/Detector    | Reception: Base language channel: 1.95 MHz<br>Translation language channel: 2.25 MHz   | Reception: Audio channel: 1.95 MHz |
| Acceptance Angle             | Vertical: 90°, Horizontal: 120°  |                                    |
| Emission Angle               | Vertical: 90°, Horizontal: 120°  |                                    |
| Covering Range               | 7 m (radius)   |                                    |
| Input                        | Microphone terminal: Combined type of XLR-4-31 (dedicated for connecting the optional TS-903 or TS-904)  |                                    |
| Output                       | Monitor speaker: 8 Ω, 0.2 W<br>Headphone: Mini Jack × 2  |                                    |
| LED Indicator (TS-901 · 902) | Speech indicator (flashes when the unit is out of communications range). Voting status indicators 1-3 (flashes when the unit is out of communications range or when the battery level is low). Power indicator (flashes when the unit is out of communications range or when the battery level is low) |                                    |
| LED Indicator (TS-801 · 802) | with "During Speech" to "Standby" ratio of 1:2   |                                    |
| Battery Life                 | Approx. 10 hours (when the fully-charged BP-900 battery is used)   |                                    |
| Operating Temperature        | 0°C to +40°C   |                                    |
| Finish                       | Top panel: ABS resin, gray metallic, paint, semi-gloss   |                                    |
| Dimensions                   | 210 (W) × 65.9 (H) × 152 (D) mm  |                                    |
| Weight                       | 640g (TS-901 · TS-902), 630g (TS-801 · TS-802)   |                                    |
| Option                       | Microphone: TS-903, TS-904 (Select either one.)<br>Lithium-ion battery: BP-900 AC adapter: AD-0910   |                                    |

| Model No.                 | TS-905  |
|---------------------------|---|
| Power Source              | 24 V DC (supplied from the optional TS-900 or TS-800)   |
| Current Consumption       | Max. 100 mA   |
| Wavelength                | 870 nm (AM: Brightness modulation)  |
| Modulation Method         | Frequency modulation  |
| Carrier Frequency         | Transmission: Audio channel 1: 7.35 MHz<br>Audio channel 2: 8.10 MHz<br>Audio channel 3: 8.55 MHz<br>Audio channel 4: 9.15 MHz<br>Control channel: 6.45 MHz |
| Infrared Emitter/Detector | Reception: Base language channel: 1.95 MHz<br>Translation language channel: 2.25 MHz  |
| Acceptance Angle          | Vertical: 150° (75° × 75°), Horizontal: 360°  |
| Emission Angle            | Vertical: 150° (75° × 75°), Horizontal: 360°  |
| Covering Range            | 7 m   |
| Connection Terminal       | BNC jack  |
| LED Indicator             | Power   |
| Operating Temperature     | 0°C to +4.0°C   |
| Finish                    | Dome: PC resin, visible light cut filter<br>Base: ABS resin, black  |
| Dimensions                | φ120 × 71.3 (H) mm  |
| Weight                    | 230 g (unit only)   |
| Accessory                 | Mounting bracket ... 1, Stand mounting bracket ... 1  |
| Option                    | Microphone stand (The mounting thread size must be W 5/16.)   |

| Model No.                | TS-903   | TS-904 |
|--------------------------|--|--------|
| Type                     | Electret condenser microphone                                |        |
| Directivity              | Unidirectional   |        |
| Rated Impedance          | 1.8k Ω   |        |
| Rated Sensitivity        | -37dB (1kHz, 0dB=1V/Pa)                                      |        |
| LED Indicator            | Speech indicator (ring type)                                 |        |
| Frequency Response       | 100~13,000Hz   |        |
| Output Connector         | Combined type of XLR-4-32                                    |        |
| Finish                   | Gooseneck: Stainless steel, black<br>Other: ABS resin, black |        |
| Weight                   | 90g  | 105g   |
| Applicable Unit (Option) | Chairman/Delegate units: TS-801, TS-802, TS-901, TS-902      |        |